

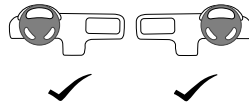

Tucson (TLe) MY 2015 -

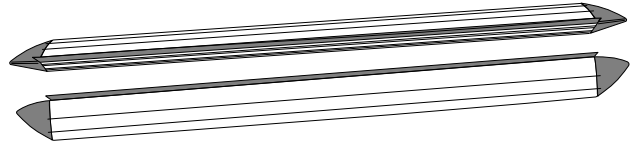

D7370ADE00
D7370ADE10



P 3 / 10



P 4 / 10

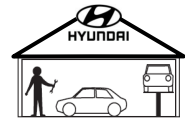
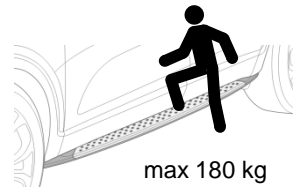

Fig 1 - 22 0.7 hr



www.mobisparts.eu



D ... RO



D ABE

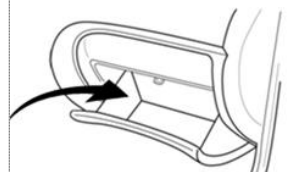

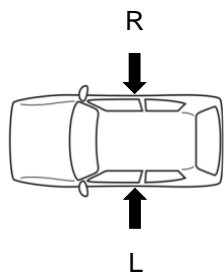
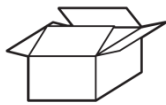

<p>D</p>	<p>Beachten Sie bitte, dass bei Schäden in Folge unsachgemäßen Einbaus sämtliche Garantieansprüche erlöschen.</p>	<p>Das Recht zu Änderungen an Inhalt von Montagesatz und Einbauanleitung ohne Vorankündigung bleibt vorbehalten. Lesen Sie vor dem Einbau diese Anleitung sorgfältig durch.</p>
<p>F</p>	<p>Nous tenons à insister tout particulièrement sur le fait que si ce produit n'est pas correctement assemblé par un technicien compétent, aucun droit de compensation ne sera recevable en cas de dommages, notamment les droits en vertu de la loi concernant la responsabilité à l'égard des produits.</p>	<p>Le contenu de ce produit, ainsi que des guides de montage qui les accompagnent est sujet à modifications sans préavis; lisez attentivement ces instructions avant de procéder à l'installation.</p>
<p>NL</p>	<p>De installatie moet worden uitgevoerd door een erkende, competente installateur. Incorrecte montage kan leiden tot het vervallen van elk recht op schadecompensatie, met name die met betrekking tot product aansprakelijkheid.</p>	<p>De inhoud van deze kits en de installatiehandleidingen kunnen worden gewijzigd zonder kennisgeving. Zorg er voor, dat u deze instructies hebt gelezen en volledig begrijpt voordat u met de installatie begint.</p>
<p>GB</p>	<p>We expressly point out that assembly not carried out properly by a competent installer will result in cancellation of any right to damage compensation, in particular those arising by virtue of the product liability act.</p>	<p>Contents of these kits and their fitting manuals are subject to alteration without notice, please ensure that these instructions are read and fully understood before commencing installation.</p>
<p>E</p>	<p>Una vez más, hacemos hincapié en el hecho de que si este producto no es instalado correctamente por un técnico cualificado, se anulará cualquier derecho de compensación por posibles daños, especialmente los relativos a la legislación vigente sobre este tipo de productos.</p>	<p>El contenido de los kits y sus correspondientes manuales de montaje están sujetos a posibles modificaciones sin previo aviso. Es importante que lea con atención todas las instrucciones y que las entienda perfectamente antes de iniciar la instalación.</p>
<p>I</p>	<p>Vi informiamo che, in caso di installazione scorretta e/o non eseguita da un installatore competente, il Cliente perderà ogni diritto a un eventuale rimborso danni e, specificamente, ogni diritto previsto dalle leggi sulla responsabilità di prodotto.</p>	<p>I contenuti di questi kit e i relativi manuali di installazione sono soggetti a modifica senza preavviso. Si raccomanda di leggere attentamente e integralmente tali istruzioni e di sincerarsi di averle comprese prima di procedere all'installazione.</p>
<p>S</p>	<p>Vi meddelar att montering, som inte görs fackmannamässigt, kommer att häva rätten till kompensation för skador, speciellt rättigheter enligt lagen om produktansvar.</p>	<p>Innehållet i dessa satser och deras bruksanvisningar kan komma att ändras utan förvarning. Vänligen läs dessa anvisningar noga innan du påbörjar monteringen.</p>
<p>CZ</p>	<p>Upozorňujeme, že instalace provedená nesprávně nebo nekompetentní osobou, ruší veškerá práva na kompenzaci škod, obzvláště těch způsobených poruchou produktu.</p>	<p>Obsah těchto sad a návody na jejich montáž podléhají změnám bez předchozího upozornění. Prosím, ujistěte se, že jste si pokyny před instalací přečetly a dostatečně jim rozumíte.</p>
<p>DK</p>	<p>Det skal understreges, at montering, der udføres af en ikke-kvalificeret montør, medfører bortfald af enhver ret til erstatning særligt i forbindelse med erstatnings-krav, der måtte opstå i kraft af loven om produktansvar.</p>	<p>Sættenes indhold og monteringsvejledninger kan ændres uden varsel, og vejledningerne skal derfor læses og forstås, før monteringen påbegyndes.</p>
<p>FIN</p>	<p>Jos asennuksen suorittaa joku muu kuin pätevä ammattilainen, tämä kumoaa asiakaan oikeuden vahingonkorvauksiin, erityisesti sellaisiin, jotka perustuvat tuotevastuulakiin.</p>	<p>Kiinnityssarjan sisältöä ja asennusohjeita voidaan muuttaa siitä etukäteen ilmoittamatta. Näihin ohjeisiin tulee perehtyä huolellisesti ennen asennuksen aloittamista.</p>
<p>GR</p>	<p>Θα πρέπει να τονιστεί ότι συναρμολόγηση που δεν πραγματοποιείται σωστά και από ειδικευμένο εγκαταστάτη οδηγεί σε ακύρωση των όποιων δικαιωμάτων αποζημίωσης έναντι ζημίας και ιδιαίτερα αυτών που προκύπτουν σύμφωνα με το νόμο περί ευθύνης προϊόντος.</p>	<p>Τα περιεχόμενα αυτών των kit και τα εγχειρίδια τοποθέτησης υπόκεινται σε αλλαγές χωρίς προειδοποίηση. Βεβαιωθείτε ότι ο οδηγός αυτές έχουν διαβαστεί και έχουν γίνει απολύτως κατανοητές προτού ξεκινήσετε την εγκατάσταση.</p>
<p>N</p>	<p>Vi bemerker at montasje som ikke utføres korrekt, av en kompetent installatør, vil resultere i annullering av all rett til erstatning for enhver skade, spesielt de som oppstår av arten produktansvar.</p>	<p>Innholdene i disse sett og deres monteringsanvisninger kan endres uten forvarsel. Vennligst påse at disse instruksjonene leses grundig og er forstått innen installasjonen startes.</p>
<p>PL</p>	<p>Pragniemy wyrażnie podkreślić, że nieprawidłowy montaż przeprowadzony przez niekompetentne osoby będzie podstawą rezygnacji z ewentualnego prawa do odszkodowania, w szczególności wynikających z mocy ustawy o odpowiedzialności za produkt.</p>	<p>Zawartość opisywanych zestawów i instrukcje ich montażu mogą ulec zmianie bez uprzedzenia; przed rozpoczęciem instalacji należy zapoznać się z instrukcjami i upewnić się, że zostały w pełni zrozumiałe.</p>
<p>RUS</p>	<p>Обратите внимание, что при повреждениях, возникших в результате неправильного монтажа, истекают все виды гарантии, в частности, касающиеся закона, регулирующего ответственность за качество продукции.</p>	<p>Производитель сохраняет за собой право на изменение содержания монтажного комплекта и инструкции по установке без предварительного уведомления. Внимательно прочитайте инструкцию перед началом установки.</p>
<p>SK</p>	<p>Upozorňujeme, že inštalácia vykonaná nesprávne alebo nekompetentnou osobou, ruší všetky práva na kompenzáciu škôd, obzvlášť tých spôsobených poruchou produktu.</p>	<p>Obsah týchto sad a návody na ich montáž podliehajú zmenám bez predchádzajúceho upozornenia. Prosím, uistite sa, že ste si pokyny pred inštaláciou prečítali a dostatočne ste im porozumeli.</p>
<p>RO</p>	<p>Vă atragem atenția că montajul efectuat incorect sau de către personal neautorizat duce la anularea oricăru drept de compensare a eventualelor daune produse utilizatorului.</p>	<p>Conținutul acestor pachete precum și al instrucțiunilor de montaj pot fi modificate fără preaviz. Vă rugăm să vă asigurați că aceste instrucțiuni sunt citite și înțelese înainte de a începe instalarea.</p>



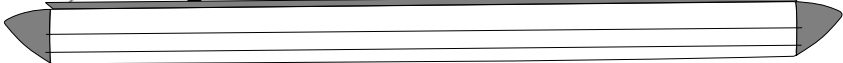

1x **(A)** R 



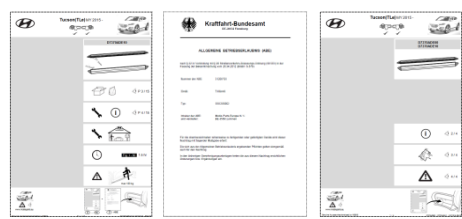
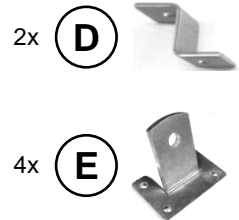
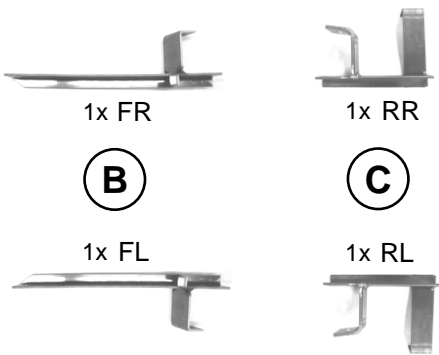

Trittbrett Typ: MHK/1 Ausf.: A
 Herst.:  Typz.: KBA
 MOBIS: D7370ADE00

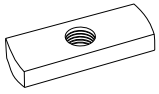
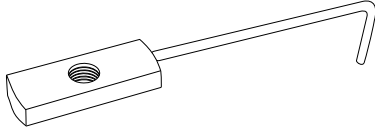

1x **(A)** L 

Trittbrett Typ: MHK/1 Ausf.: B
 Herst.:  Typz.: KBA
 MOBIS: D7370ADE10



(F)		(G)		(H)	
6x	M10	2 x	M10	16x	M6 x 16 mm

(I)		(J)		(K)		(L)	
8x	M10 x 30	6 x	M10 x 30	16 x	Ø 6,4	6x	M10

(M)		(N)	
14x	Ø 10,2	4x	Ø 10,5

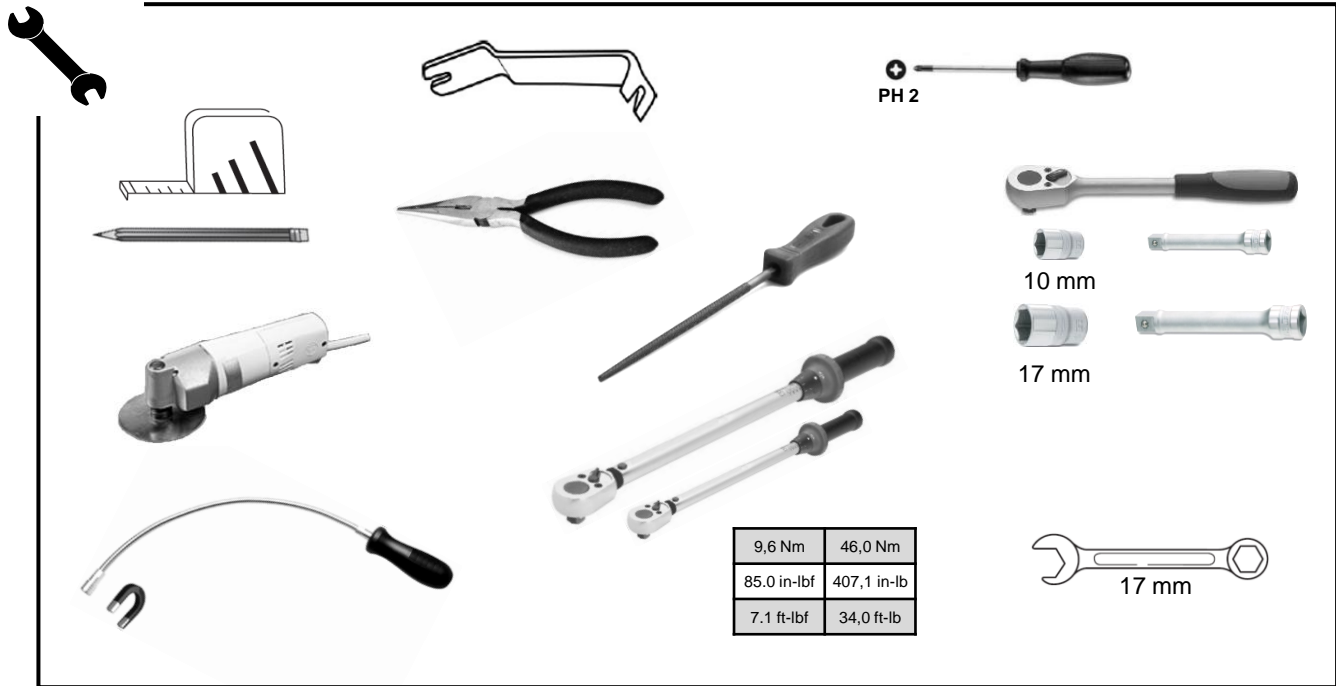

PH 2

10 mm

17 mm

9,6 Nm	46,0 Nm
85,0 in-lbf	407,1 in-lb
7,1 ft-lbf	34,0 ft-lb

17 mm

i

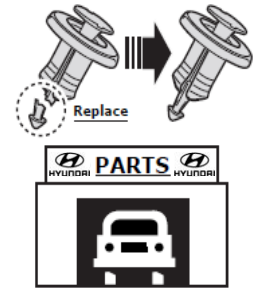
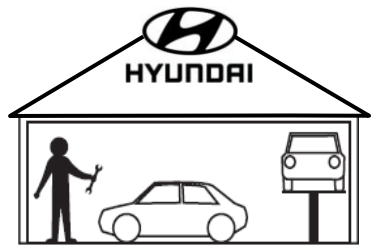



L & R

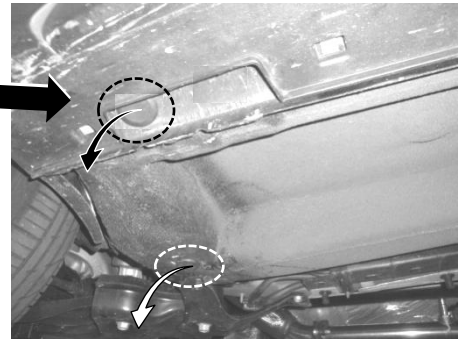
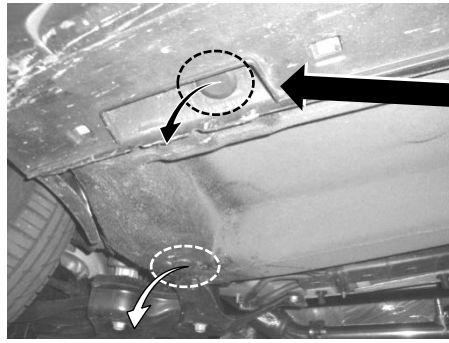

L & R

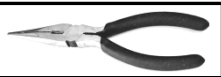
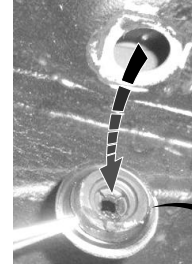

Fig 1



L & R

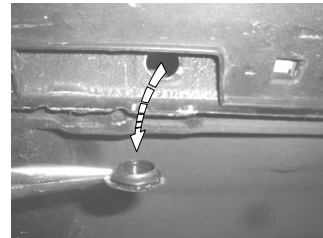
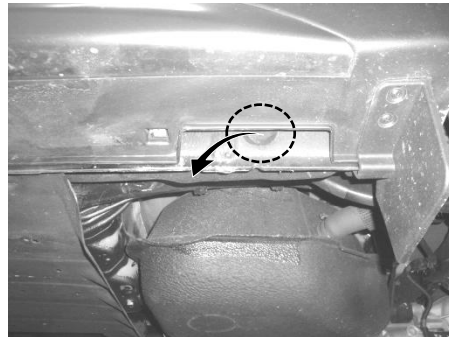

Fig 20



Fig 2



L & R

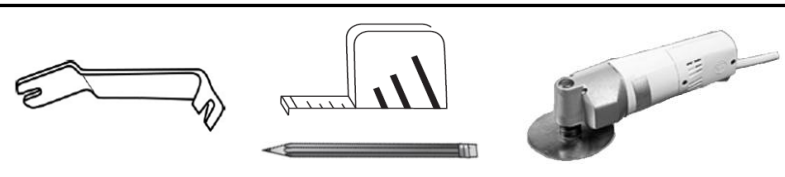
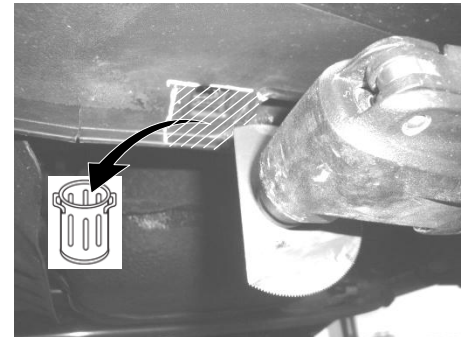
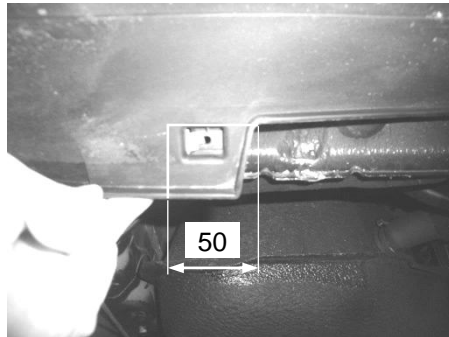
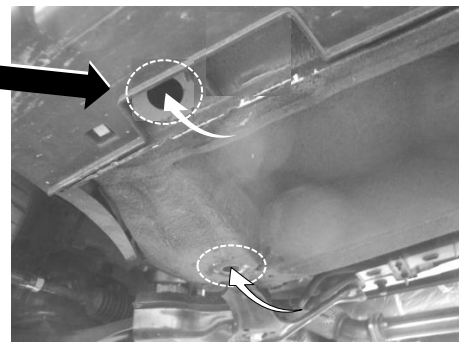
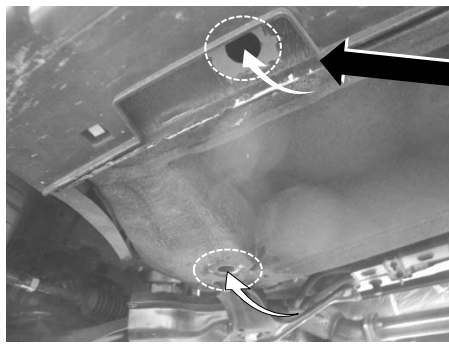

Fig 3



L & R



F

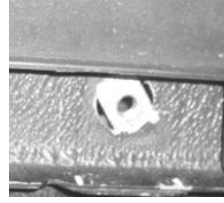
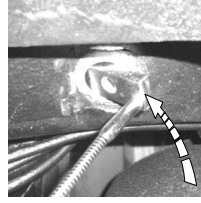
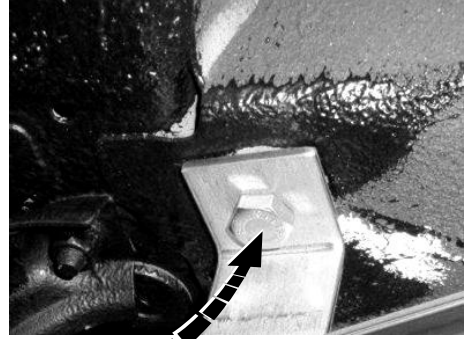

Fig 4



L & R



D

M

I



17 mm

Fig 5



L & R

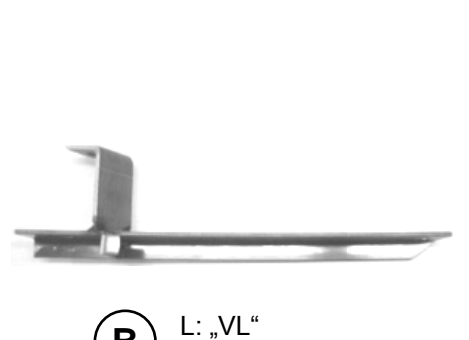
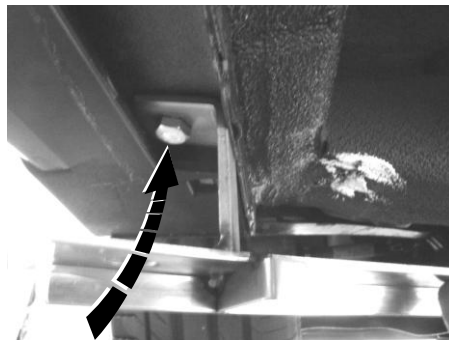

B

L: „VL“
R: „VR“

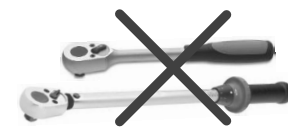

M

I



17 mm

Fig 6



L & R

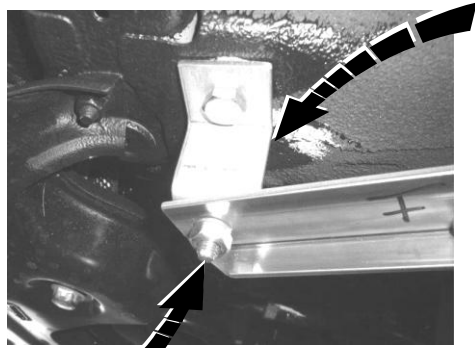

J

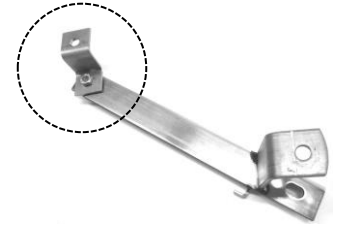

M



L



Fig 7



L & R

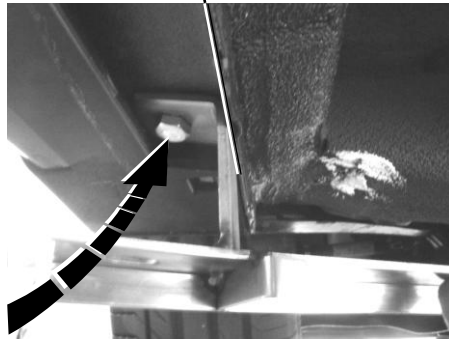
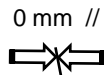

46,0 Nm

407,1 in-lb

34,0 ft-lb



17 mm

Fig 8



L & R

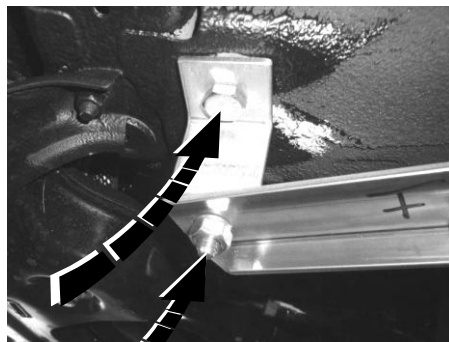

46,0 Nm

407,1 in-lb

34,0 ft-lb



17 mm

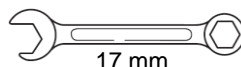

17 mm

Fig 9



Fig 10

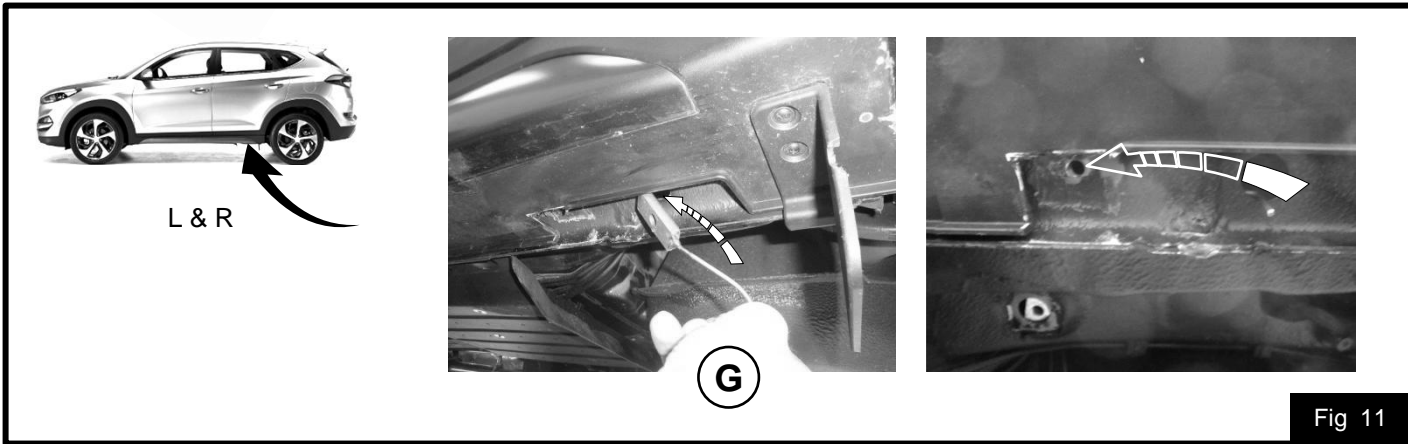

Fig 11

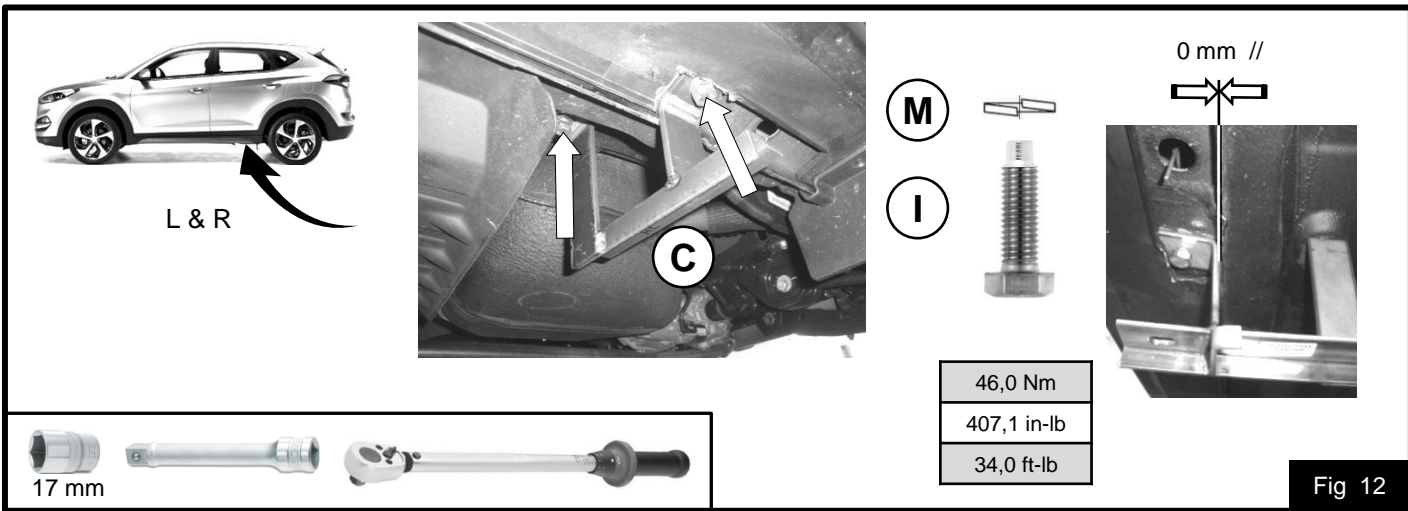

Fig 12

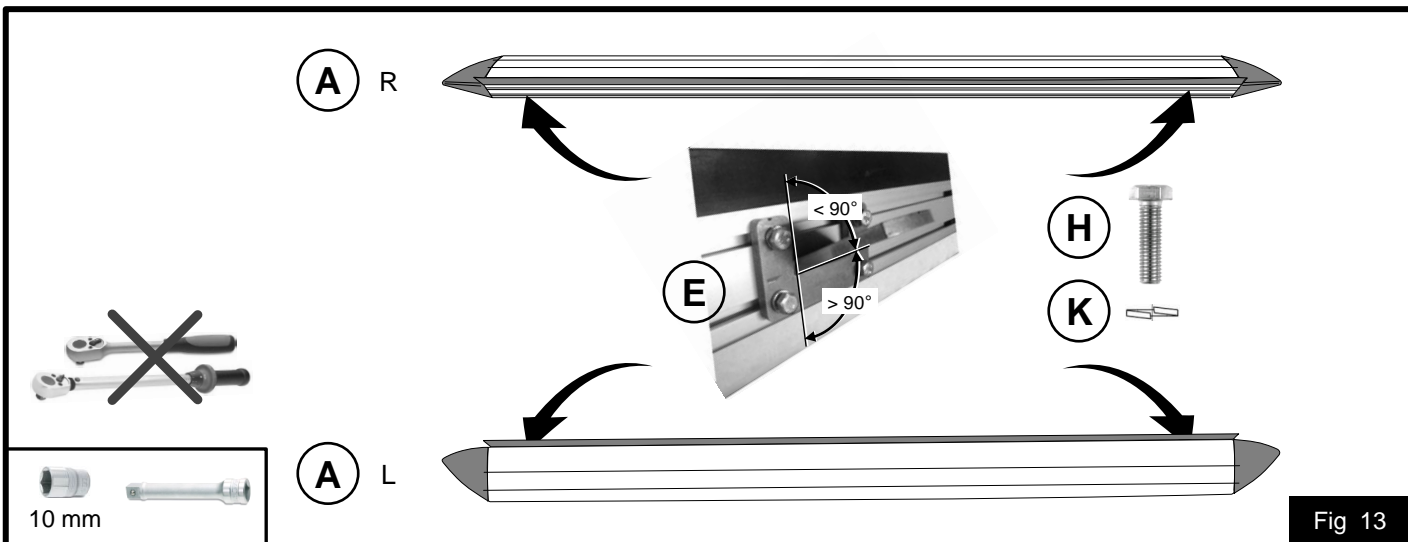
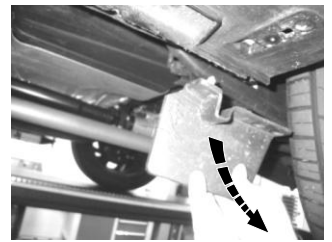
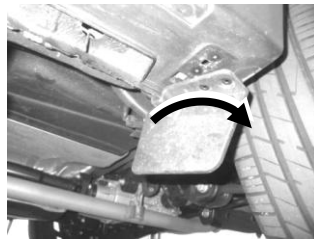

Fig 13



L & R



Fig 22

PH 2



Fig 14

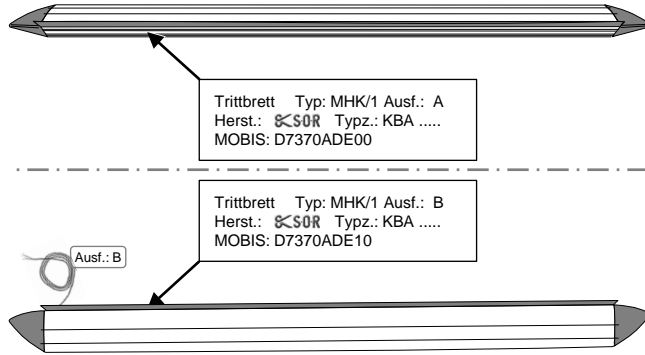
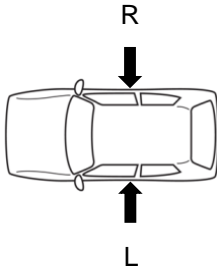

Fig 15

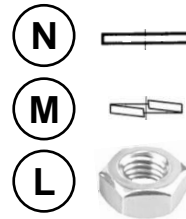
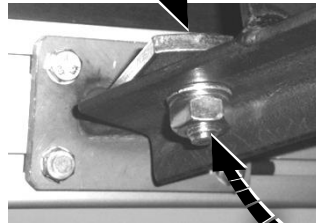
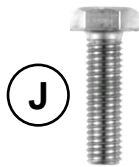
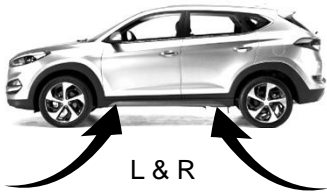
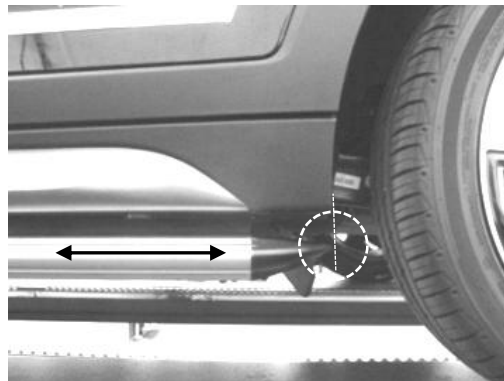

Fig 16



L & R

Fig 17

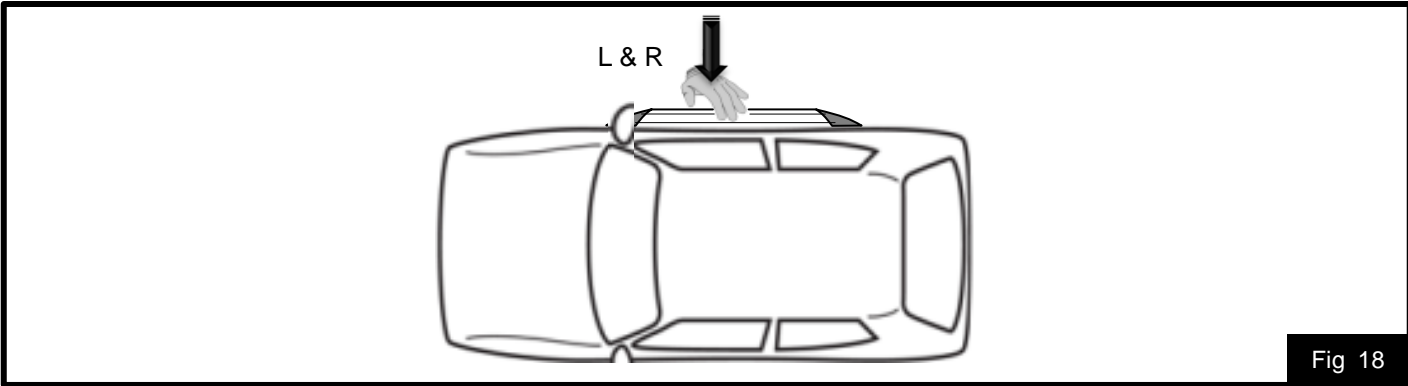

Fig 18

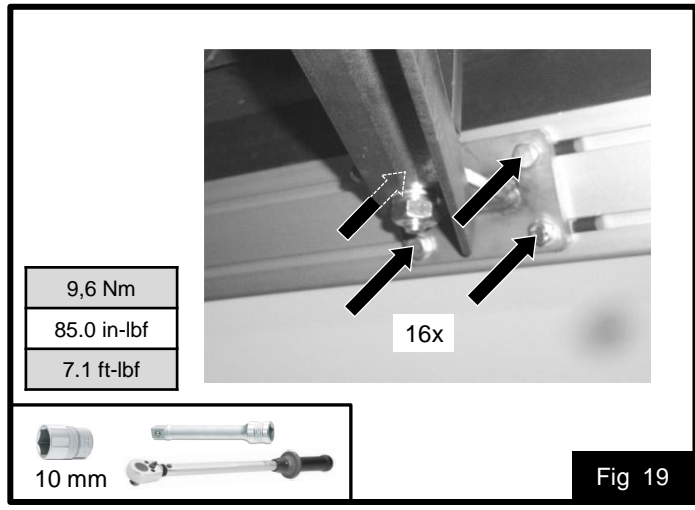
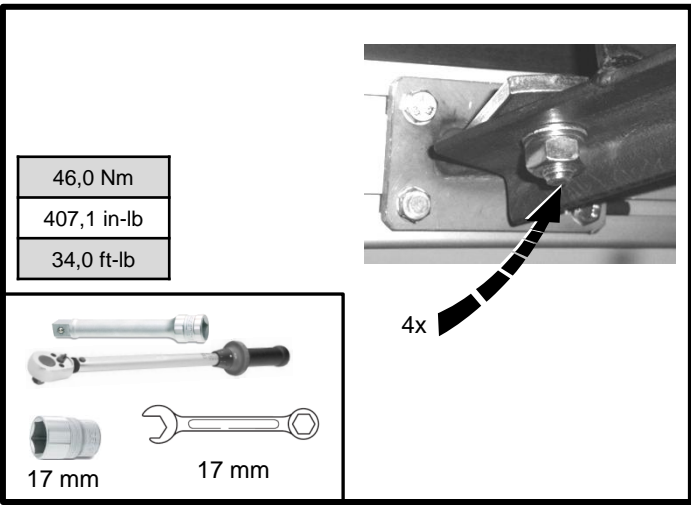

Fig 19

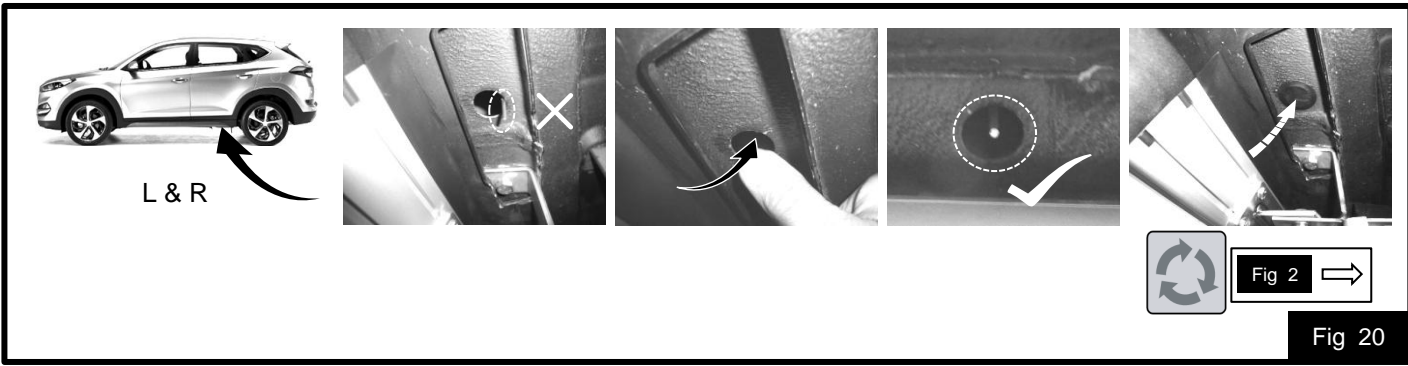

Fig 20

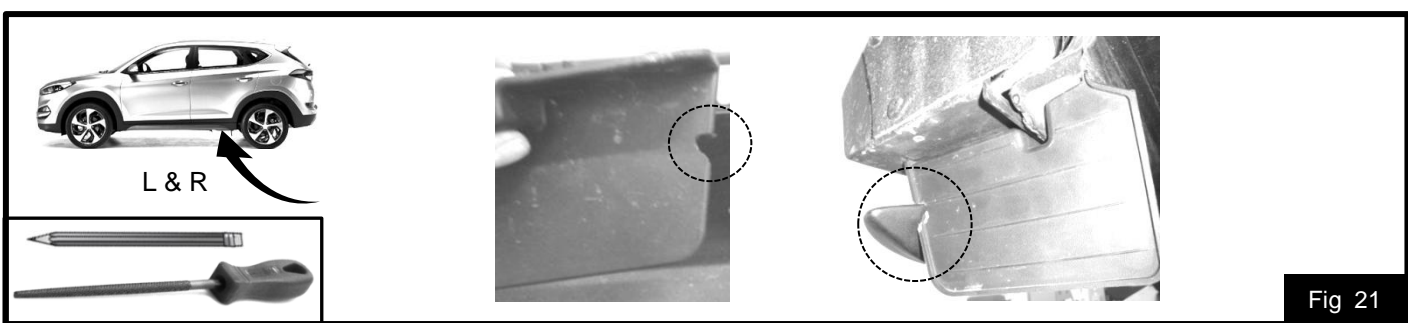

Fig 21

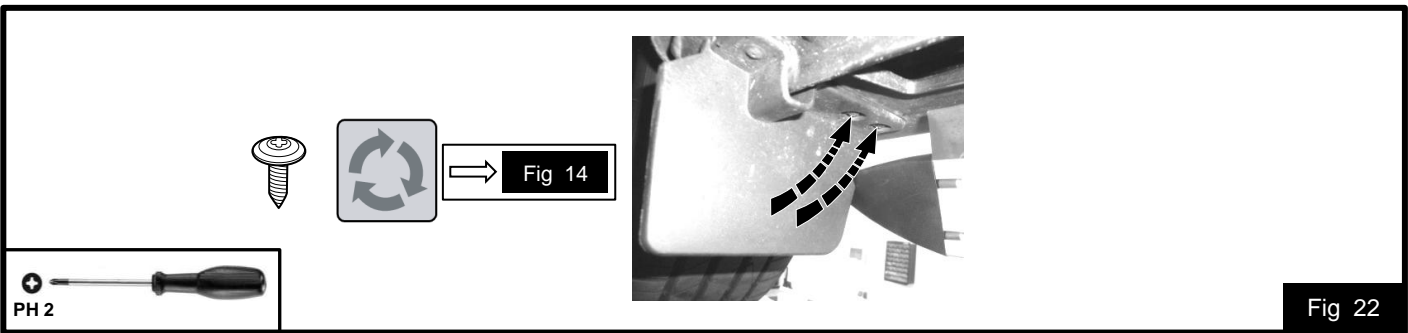

Fig 22