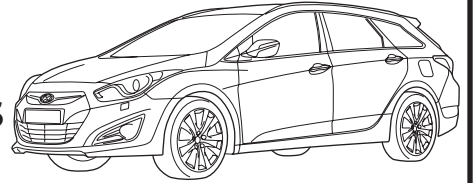

**HYUNDAI**

30 Minutes

INSTALLATION INSTRUCTIONS**Hyundai i40 2011-****Part no. 3Z420ADE20BL**

(DE) Montageanleitung Unterfahrschutz	(CZ) Návod k montáži ochrana proti podjetí
(FR) Notice de montage Enjoliveur	(DK) Monteringsvejledning Underkøringsbeskyttelse
(NL) Inbouw-instructie Beschermplaat	(FI) Asennusohje Alleajosuora
(GB) Fitting instruction Skid plate	(GR) Οδηγίες τοποθέτησης Προστασία έναντι ενσφηνώσεως
(ES) Instrucciones de montaje Cubrecárter	(NO) Monteringsveiledning Underkjøringshinder
(IT) Istruzioni di montaggio Protezione antincastro	(PL) Instrukcja instalowania Ostona dolna zderzaka
(SE) Monteringsanvisning Slirplat	(RU) Инструкция по монтажу Защитная пластина сзади

PRE-INSTALLATION CAUTIONS/NOTES:

(DE) - Beachten Sie bitte, dass bei Schäden in Folge unsachgemäßen Einbaus sämtliche Garantieansprüche erlöschen, insbesondere solche, die das Produkthaftungsgesetz betreffen.	- Das Recht zu Änderungen an Inhalt von Montagesatz und Einbauanleitungen ohne Vorankündigung bleibt vorbehalten. Lesen Sie vor dem Einbau diese Anleitung sorgfältig und gewissenhaft durch.
(FR) - Nous tenons à insister tout particulièrement sur le fait que si ce produit n'est pas correctement assemblé par un technicien compétent, aucun droit de compensation ne sera recevable en cas de dommages, notamment les droits en vertu de la loi concernant la responsabilité à l'égard des produits.	- Le contenu de ces kits, ainsi que des guides de montage qui les accompagnent est sujet à modifications sans préavis ; lisez attentivement ces instructions avant de procéder à l'installation.
(NL) - We zouden expliciet willen benadrukken dat installatie die niet correct wordt uitgevoerd door een bekwame installateur kan leiden tot het vervallen van elk recht op schadecompensatie, vooral de compensatie op basis van de productaansprakelijkheidsovereenkomst.	- De inhoud van deze kits en de installatiehandleidingen kunnen worden gewijzigd zonder kennisgeving. Zorg er dus voor dat u deze instructies hebt gelezen en volledig begrijpt voordat u met de installatie begint.
(GB) - We would expressly point out that assembly not carried out properly by a competent installer will result in cancellation of any right to damage compensation, in particular those arising by virtue of the product liability act.	- Contents of these kits and their fitting manuals are subject to alteration without notice, please ensure that these instruction are read and fully understood before commencing installation.
(ES) - Una vez más, hacemos hincapié en el hecho de que si este producto no lo monta correctamente un técnico instalador cualificado, se anulará cualquier derecho de compensación por posibles daños, especialmente los relativos a la legislación vigente sobre este tipo de productos.	- El contenido De los kits y sus correspondientes manuales De montaje están sujetos a posibles modificaciones sin previo aviso. Es importante que lea con atención todas las instrucciones y que las entienda perfectamente antes De iniciar la instalación.
(IT) - Si prega di notare che, in caso di installazione scorretta non eseguita da un installatore competente, l'utente perderà ogni diritto a un eventuale rimborso danni e, specificamente, ogni diritto previsto dalle leggi sulla responsabilità di prodotto.	- I contenuti di questi kit e i relativi manuali di installazione sono soggetti a modifica senza preavviso. Si raccomanda di leggere attentamente e integralmente tali istruzioni e di sincerarsi di averle comprese prima di procedere all'installazione.
(SE) - Vi vill uttryckligen meddela att montering som inte görs fackmannamässigt av en kompetent montör, kommer att häva rätten till kompensation för skador, speciellt rättigheter enligt lagen om produktansvar.	- Innehållet i dessa satser och deras bruksanvisningar kan komma att ändras utan föregående meddelande. Vänligen läs dessa anvisningar noga innan du påbörjar monteringen.
(CZ) - Upozorňujeme, že instalace provedená nesprávně nebo nekompetentní osobou, ruší veškerá práva na kompenzaci škod, obzvláště způsobených poruchou produktu.	- Obsah těchto sad a návody na jejich montáž podléhají změnám bez předchozího upozornění. Prosím, ujistěte se, že jste si pokyny před instalací přečetly a dostatečně jim rozumíte.
(DK) - Det skal understreges, at montering, der udføres af en ikke-kvalificeret monter, medfører bortfald af enhver ret til erstatning særligt i forbindelse med erstatningskrav, der måtte opstå i kraft af loven om produktansvar.	- Sættenes indhold og monteringsvejledninger kan ændres uden varsel, og vejledningerne skal derfor læses og forstås, før monteringen påbegyndes.
(FI) - Jos asennuksen suorittaa joku muu kuin pätevä ammattilainen, tämä kumoo asiakkaan oikeuden vahingonkorvauksiin, erityisesti sellaisiin, jotka perustuvat tuotevastuulakiin.	- Kiiinnitysarjan sisältöä ja asennusoppaita voidaan muuttaa siitä etukäteen ilmoittamatta. Asiakkaan tulee ennen asennuksen aloittamista perehtyä huolellisesti näihin ohjeisiin.
(GR) - Θα πρέπει να τονιστεί ότι συναρμολόγηση που δεν πραγματοποιείται σωστά και από ειδικευμένο εγκαταστάτη οδηγεί σε ακύρωση των όποιων δικαιωμάτων αποζημίωσης έναντι ζημίας και ιδιαίτερα αυτών που προκύπτουν σύμφωνα με το νόμο περί ευθύνης προϊόντος.	- Τα περιεχόμενα αυτών των kit και τα εγχειρίδια τοποθέτησης υπόκεινται σε αλλαγές χωρίς προειδοποίηση. Βεβαιωθείτε ότι ο οδηγίες αυτές έχουν A:BC διαβαστεί και έχουν γίνει απολύτως κατανοητές προτού ξεκινήσετε την εγκατάσταση.
(NO) - Vi bemerker at montasje som ikke utføres korrekt, av en kompetent installatør, vil resultere i annullering av all rett til erstatning for enhver skade, spesielt de som oppstår av arten produktansvar.	- Innholdene i disse sett og deres monteringsanvisninger kan endres uten forvarsel. Vennligst påse at disse instruksjonene leses grundlig og er forstått innen installasjonen startes.
(PL) - Pragniemy zwrócić uwagę na fakt, że nieprawidłowy montaż przeprowadzony przez niekompetentne osoby będzie podstawą do unieważnienia wszelkich praw do odszkodowań, w szczególności wynikających z ustaw o odpowiedzialności za produkt.	- Zawartość opisywanych zestawów i instrukcje ich montażu mogą ulegać zmianom bez powiadomienia; przed rozpoczęciem instalacji należy zapoznać się z instrukcjami i upewnić się, że zostały zrozumiane.
(RU) - Обратите при повреждениях, возникших в результате неправильного монтажа, истекают все виды гарантии, в частности, касающиеся закона, регулирующего ответственность за качество продукции.	- Право изменения содержания монтажного комплекта и инструкции по установке без предварительного оповещения производитель оставляет за собой. Внимательно прочитайте инструкцию перед тем, как начать установку.

INSTALLATION INSTRUCTIONS - Skid plate (3Z420ADE20BL)

- Einzelteilliste (DE) Liste de pièces (FR) Onderdelenlijst (NL) Part list (GB) Lista de componentes (ES) Elenco componenti (IT) Dellista (SE) Seznam dílů (CZ) Del-liste (DK) Osaluettelo (FI) Κατάλογος εξαρτημάτων (GR) Delliste (NO) Lista części (PL) Список деталей (RU)

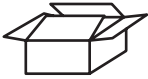

3Z420ADE20BL

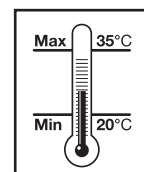
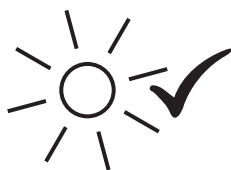
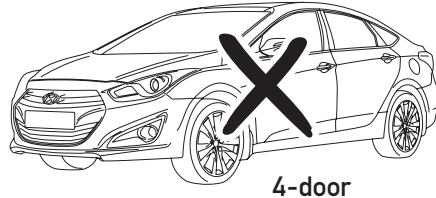
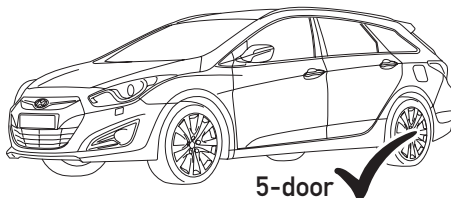
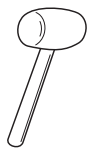
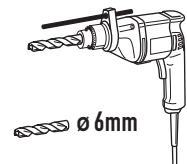
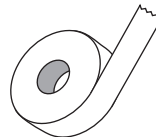
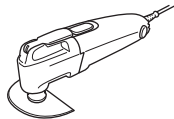
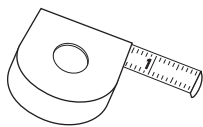
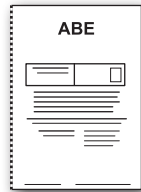
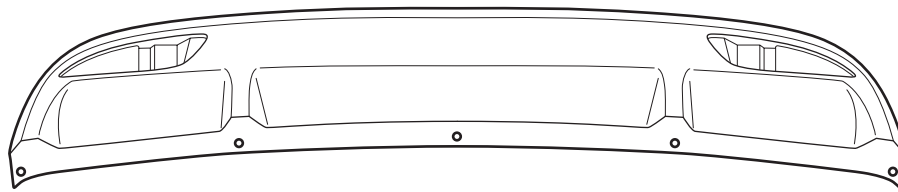

INSTALLATION INSTRUCTIONS - Skid plate (3Z420ADE20BL)

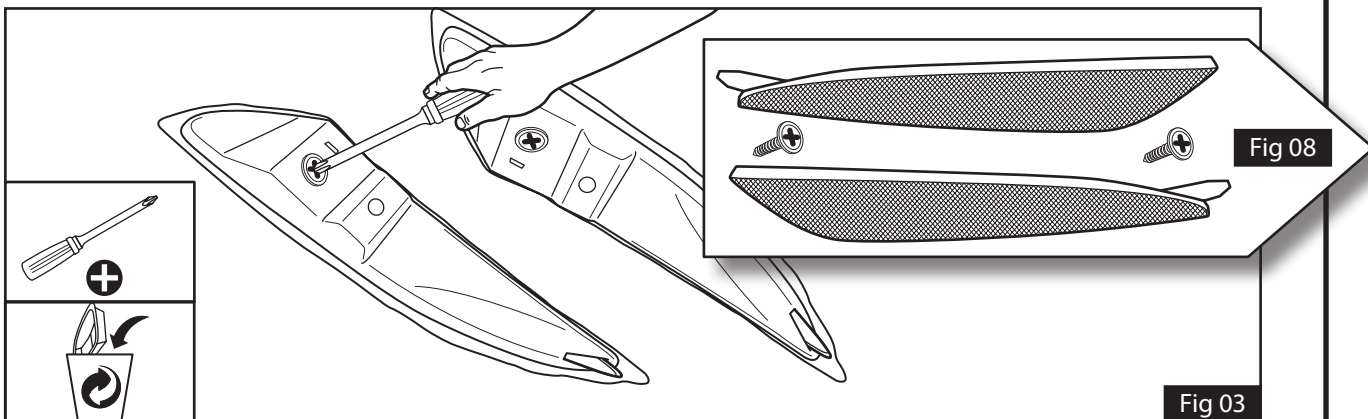
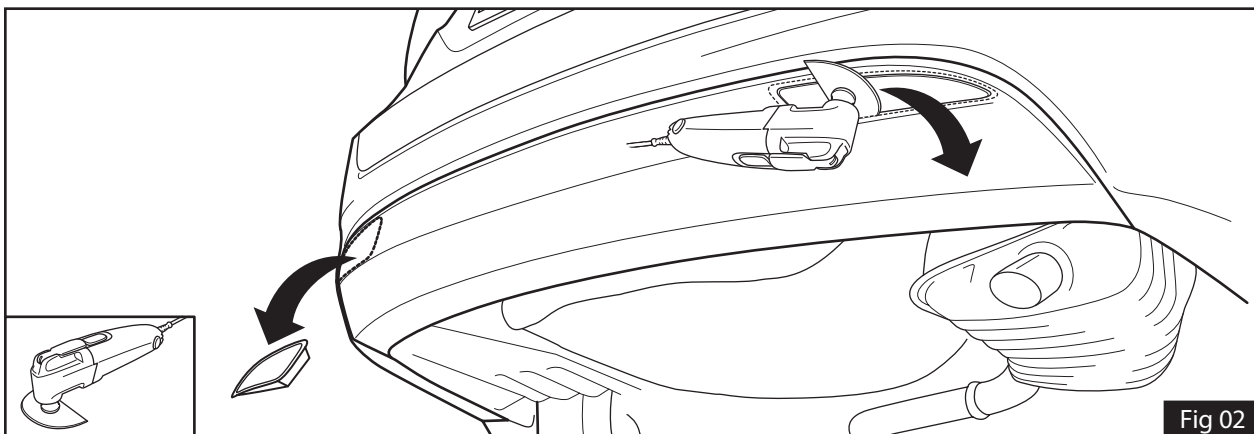
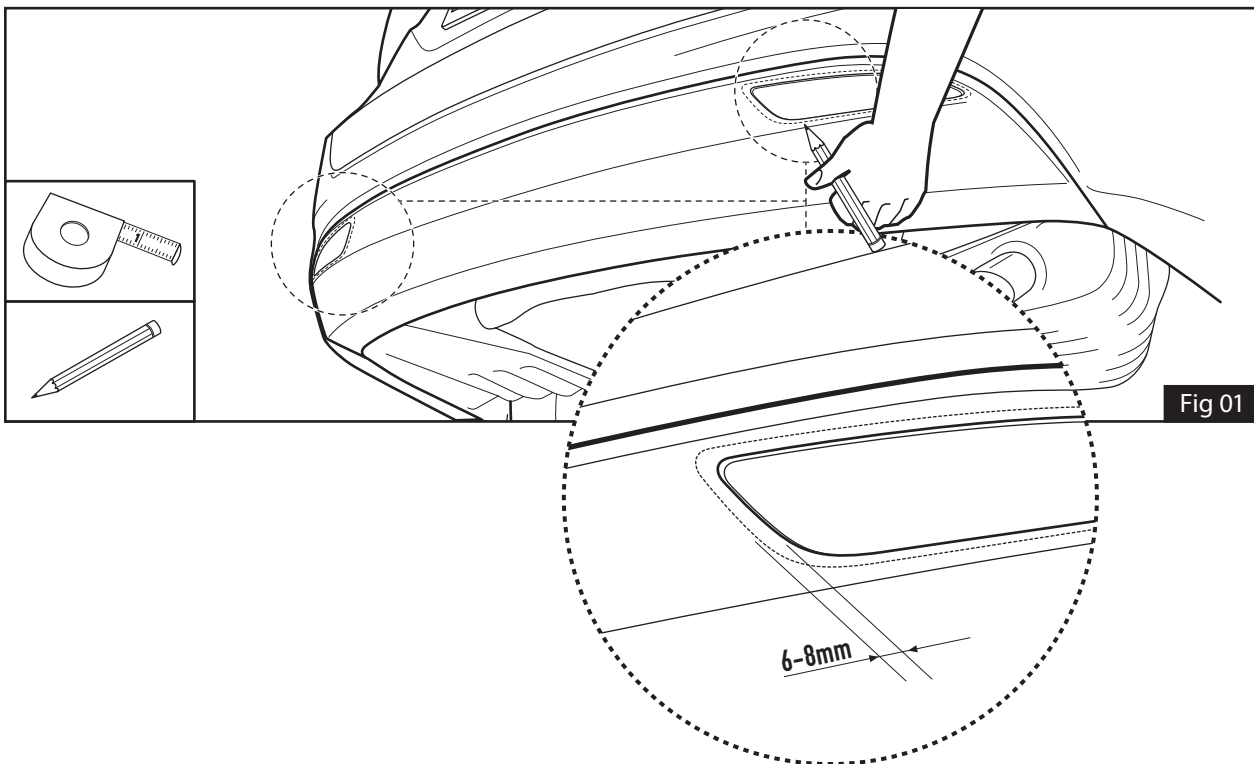

INSTALLATION INSTRUCTIONS - Skid plate (3Z420ADE20BL)

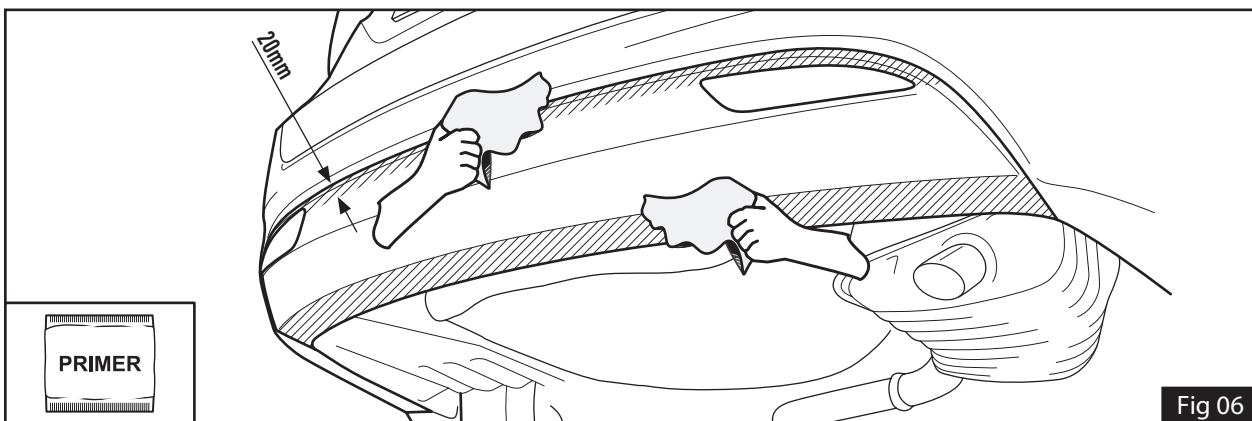
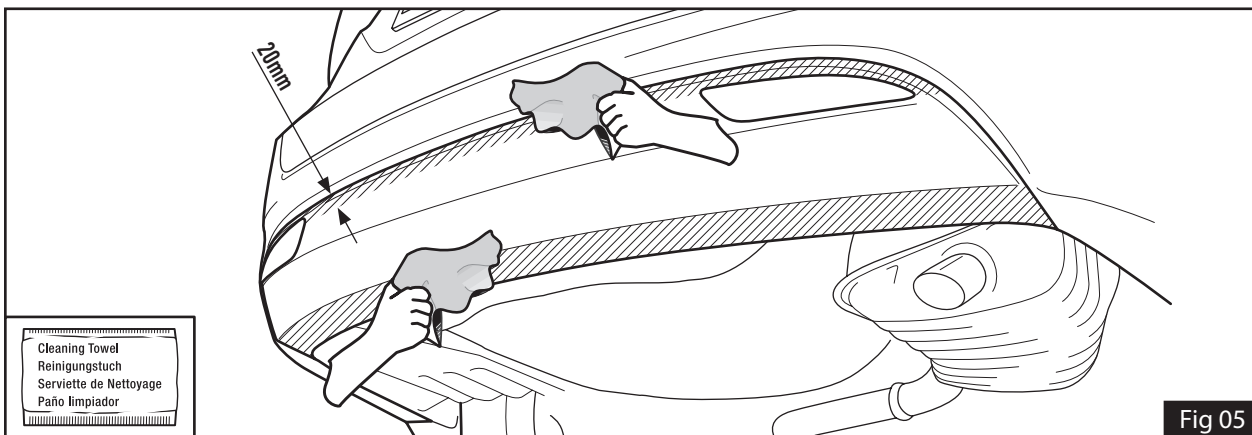
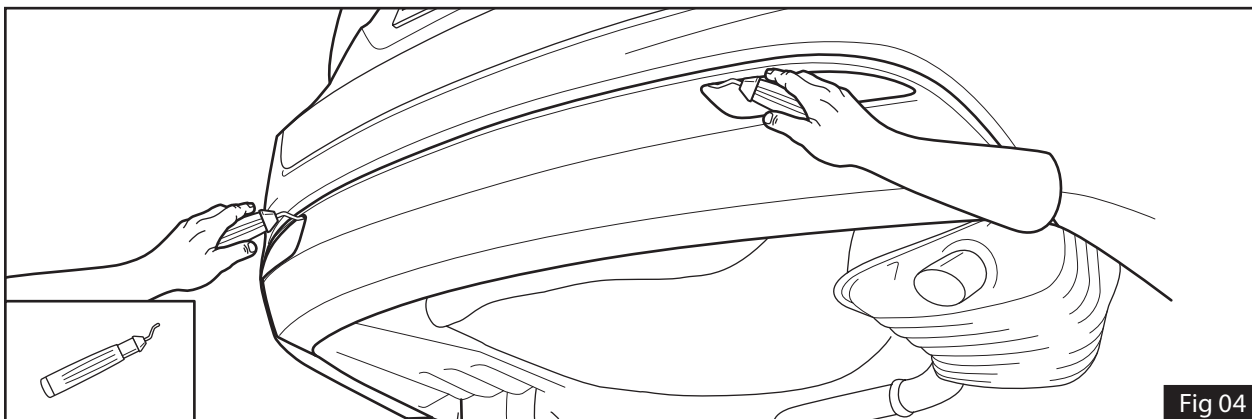

5 Minutes



Fig 08

Fig 07

INSTALLATION INSTRUCTIONS - Skid plate (3Z420ADE20BL)

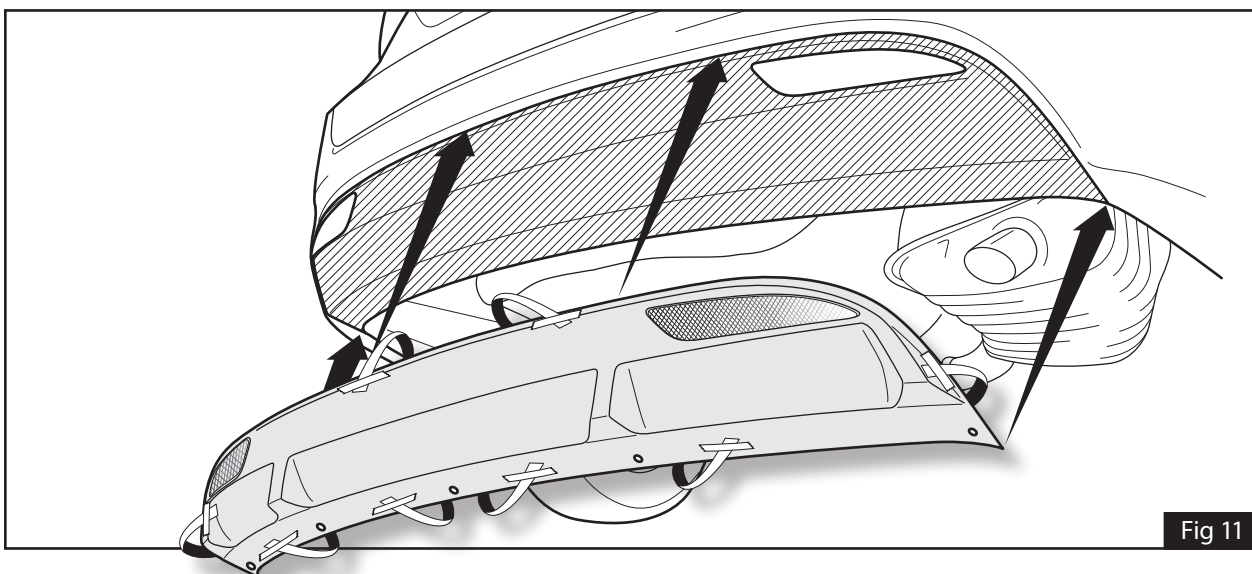
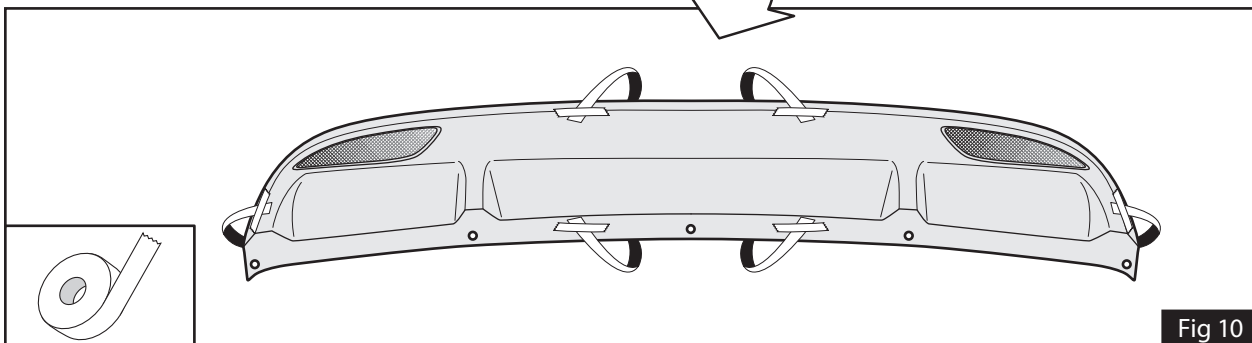
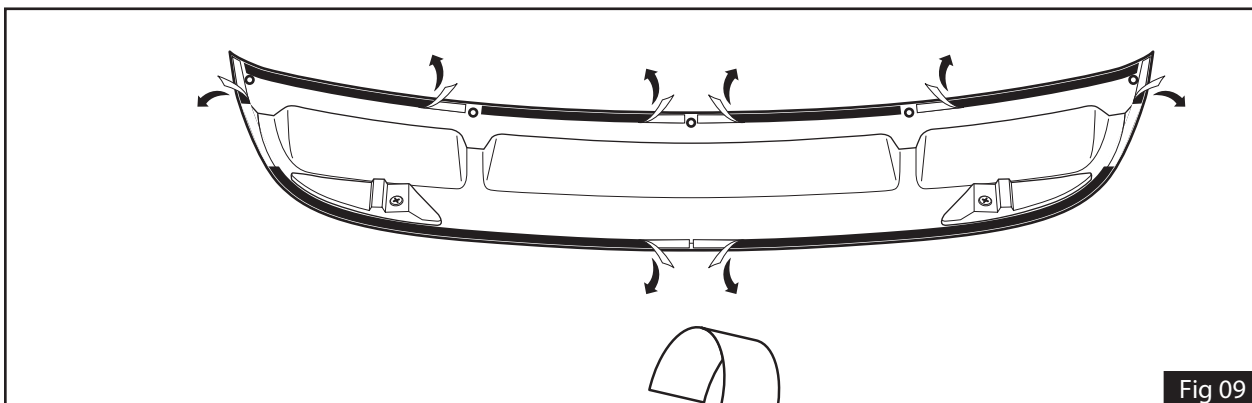
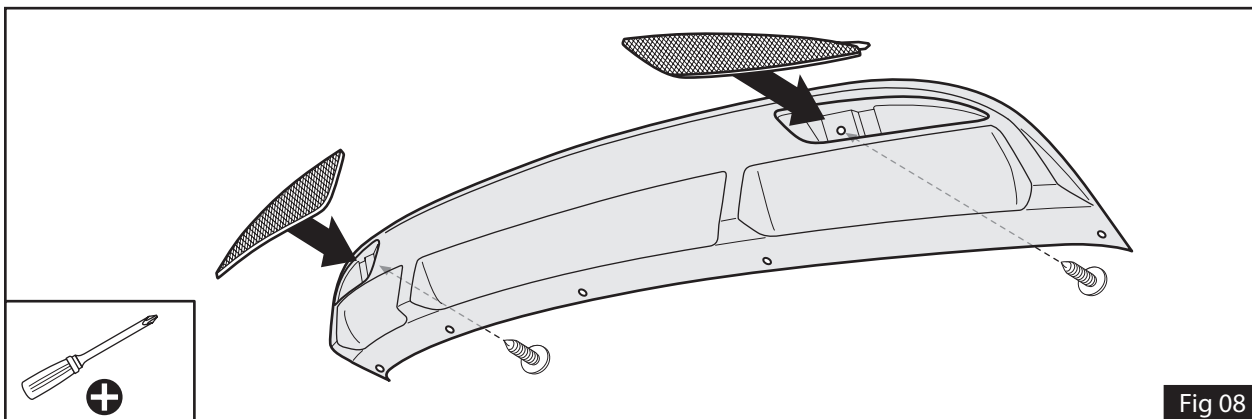

INSTALLATION INSTRUCTIONS - Skid plate (3Z420ADE20BL)

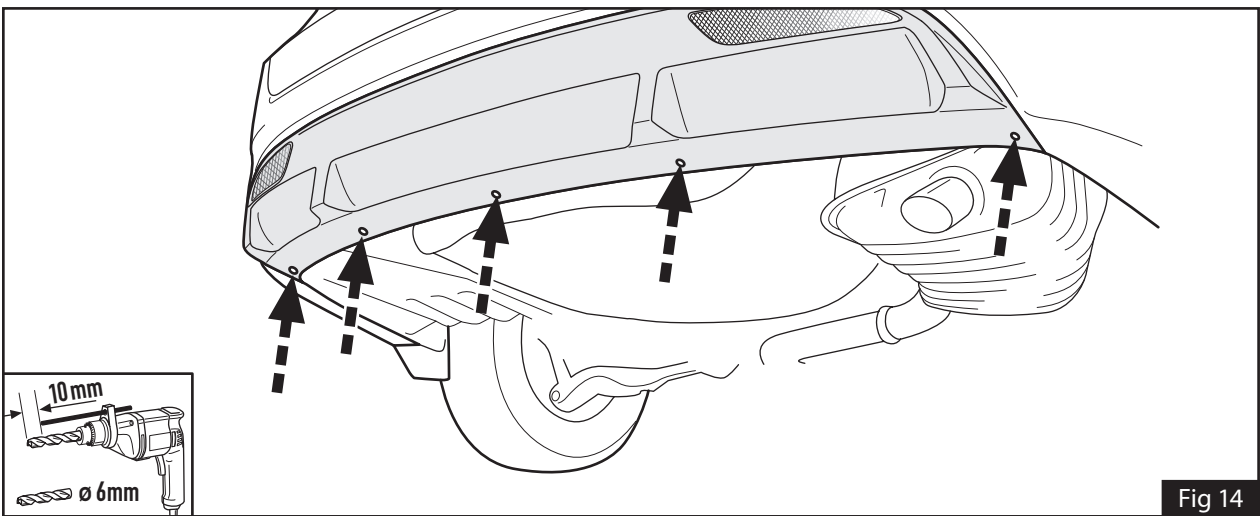
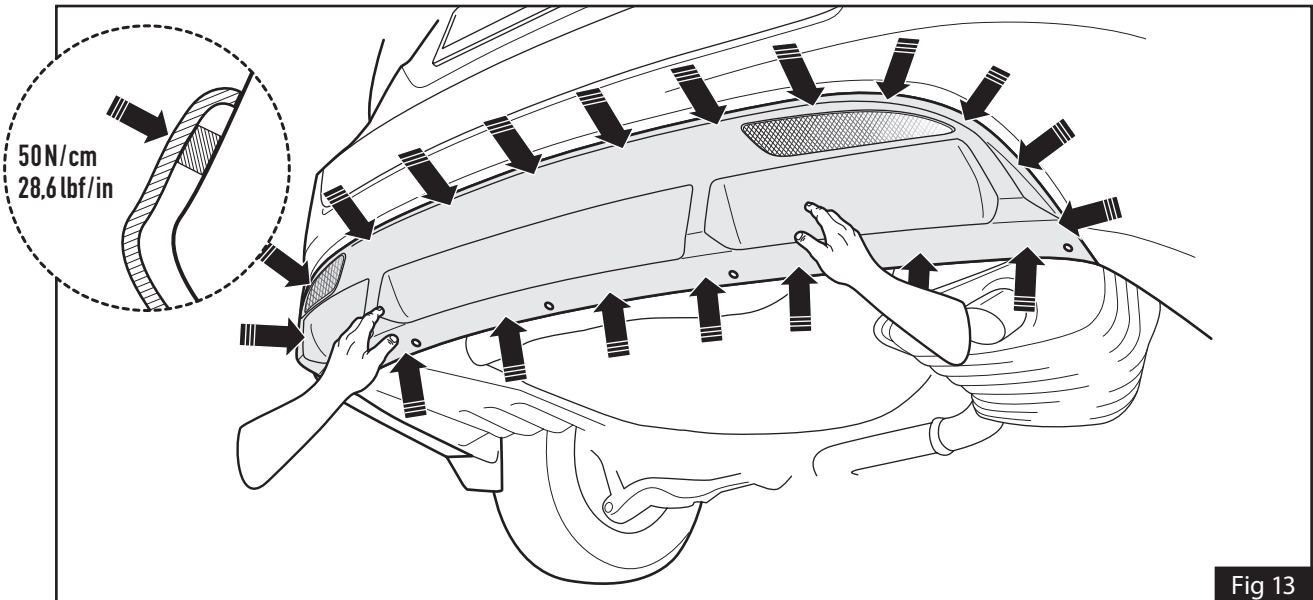
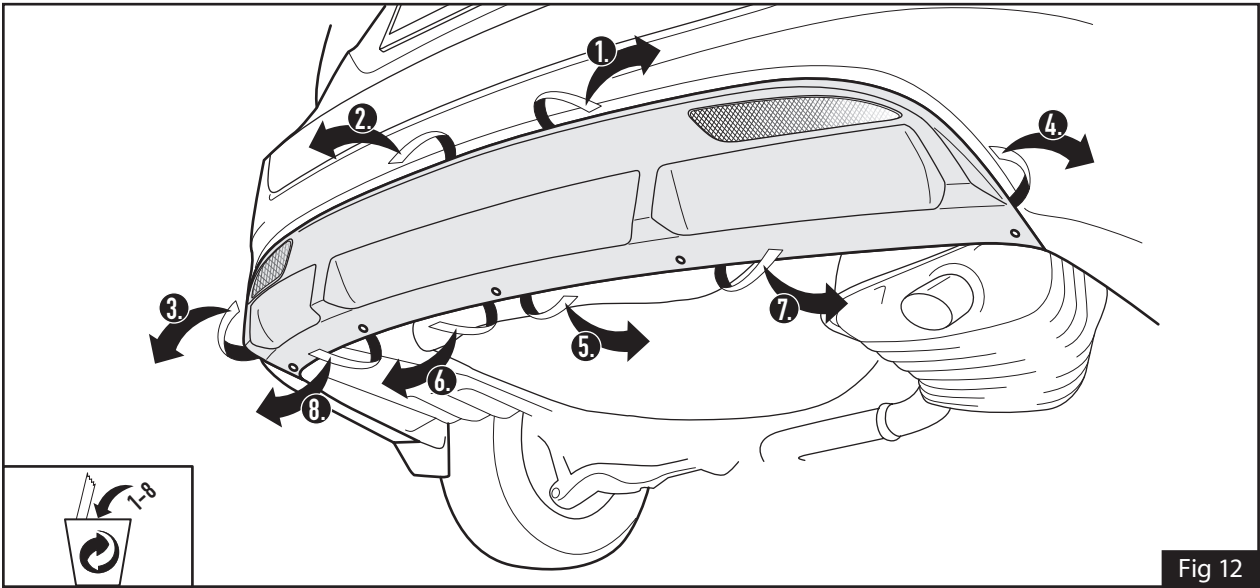

INSTALLATION INSTRUCTIONS - Skid plate (3Z420ADE20BL)

